

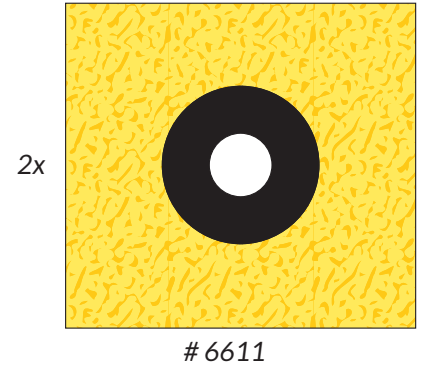

Mauer Variante

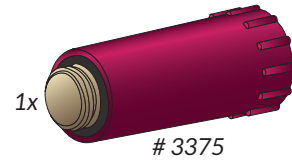

DIN 18534-1

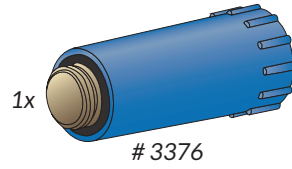
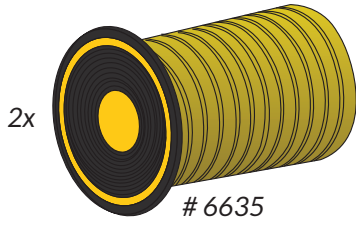
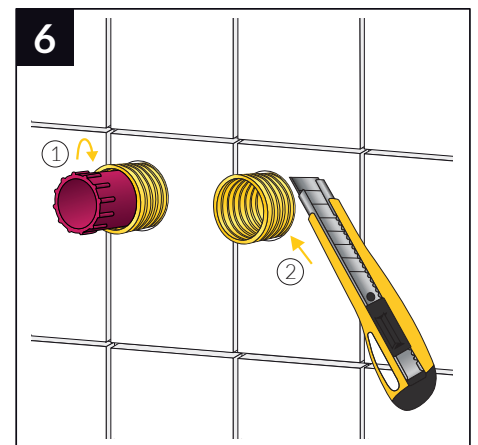
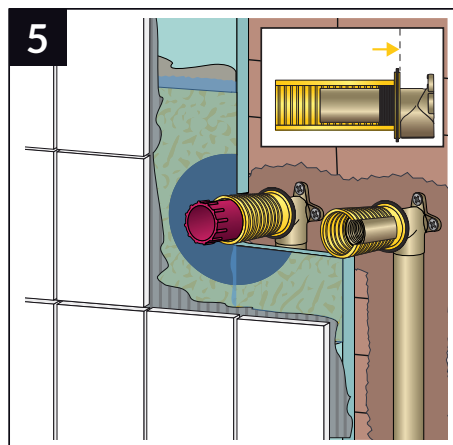
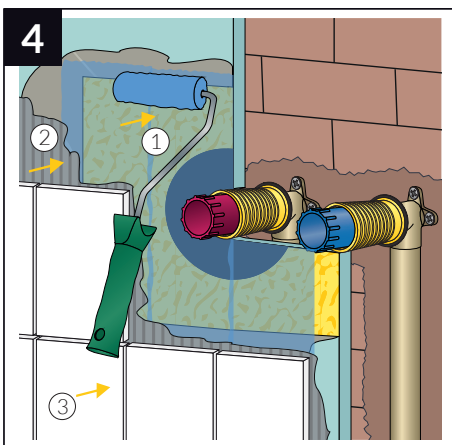
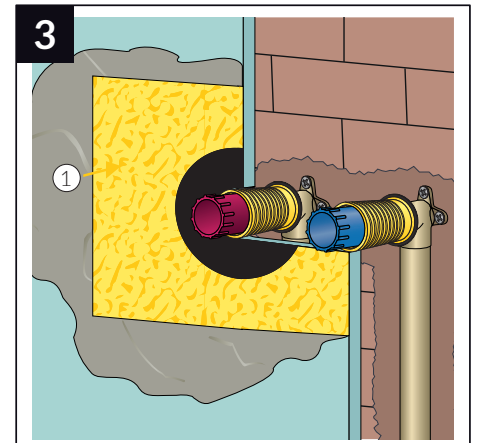
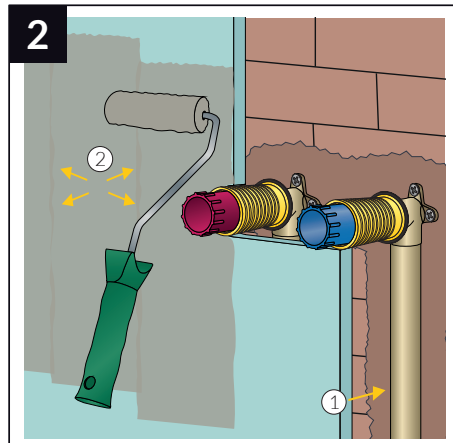
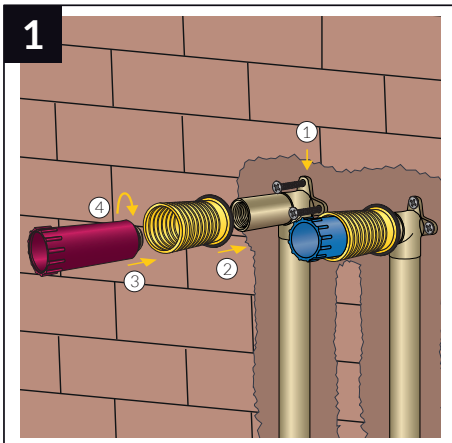



Trockenbau Variante

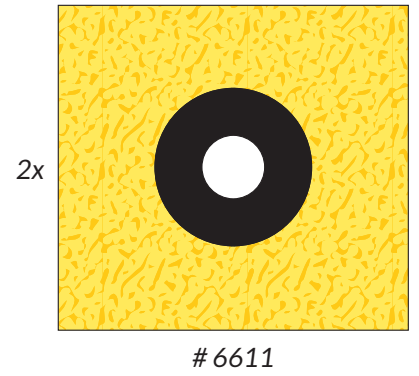
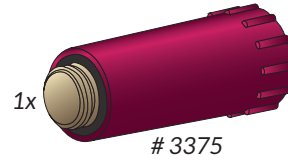
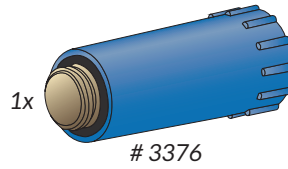
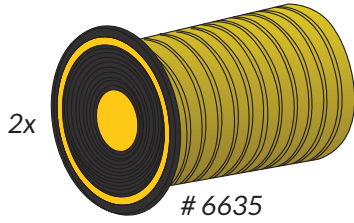

DIN 18534-1

